

## Membránová čerpadla série P - DL 80

Tato série DL se týká plastových membránových čerpadel. Plastová membránová čerpadla série P jsou vhodná pro všeobecné použití v průmyslu ale především v chemickém a farmaceutickém průmyslu.

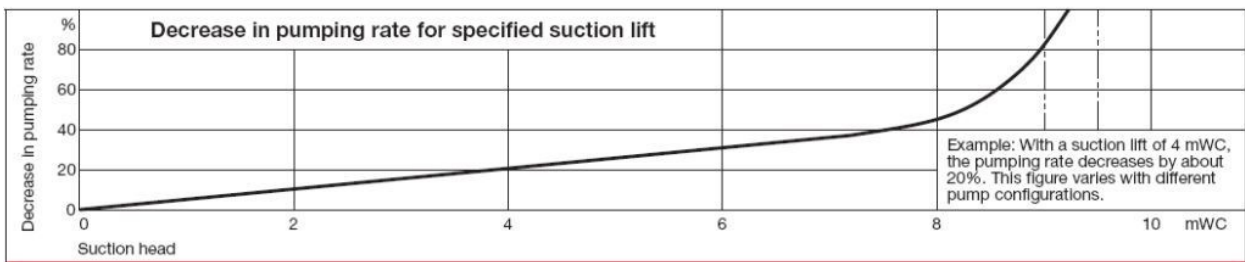
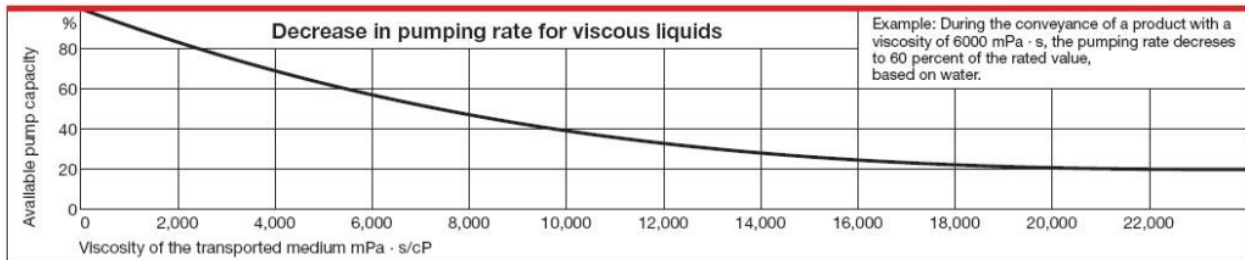

### Rozměry:

Typ	G	DN	A	B	C	D	E	F	G	H	I	K	Vzduc h G
DL 08	1/4"	8											
DL 10	3/8"	10											
DL 15	1/2"	15	156	190	180	225	31	28	34		90	120	1/4"
DL 25	1"	25	190	236	241	322	61	35	84	71	141	200	3/8"
DL 40	1 1/2"	40	220	310	305	406	72	50	84	93	179	255	3/8"
DL 50	2"	50	280	412	414	540	88	65	105	125	245	340	3/4"
DL 80	3"	80	350	512	522	680	105	80	105	160	304	420	3/4"

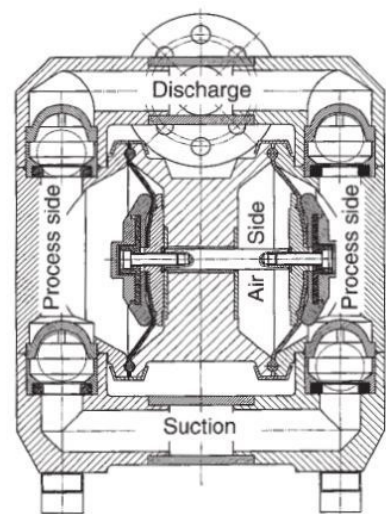
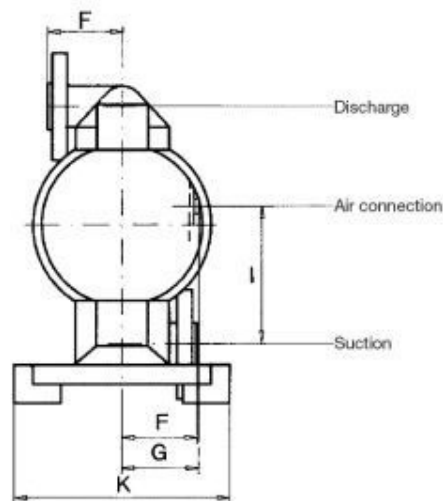
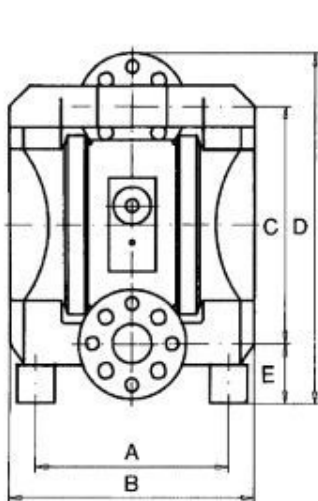

## Charakteristika čerpadla:

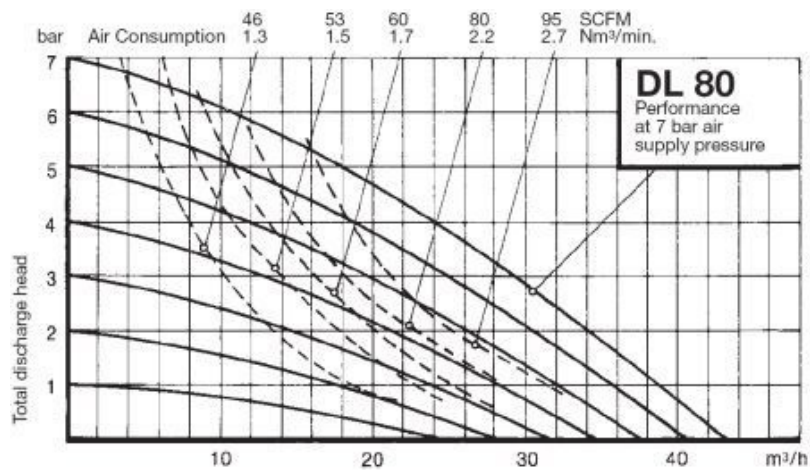

## Materiálové provedení:

	DL 15	DL 25	DL 40	DL 50	DL 80
PP	•	•	•	•	•
PL	•	•	•	•	
PV	•	•	•	•	
PT	•	•	•	•	
TL	•	•	•	•	

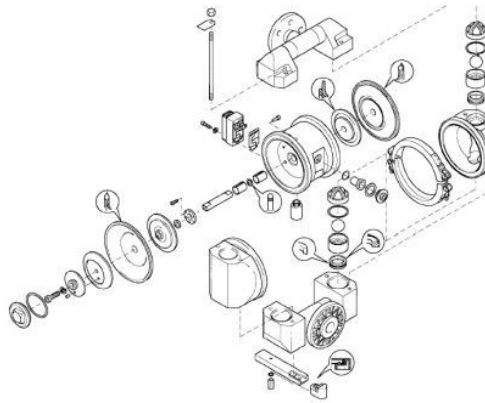

	Komora	Píst	Blok
PP	pp	pp	pp
PL	pp e	pp e	pp e
PV	PVDF	PVDF	pp
PT	PTFE	PTFE	pp
TL	PTFE e	PTFE e	PTFE e

## Materiály těsnění:

	Membrána	Sedlo	Koule
NRS	B	B	B
NBR	N	N	N
EPDM n	E	E	E
EPDM g	G		G
FKM	F	F	
PTFE	T	T	T
Nerez			R
NBR SC			Y
EPDM SC			W
EPDM G SC			X
PTFE SC			Z

## Typové označení:

DL 80-PT-TTT

PT= Materiálové provedení PT - PTFE / PTFE / pp

TTT= Materiál těsnění - TTT - PTFE / PTFE / PTFE